

ECB Series BACnet[®] Controllers



Figure 1: From left to right: ECB-650 with operator interface, ECB-410 with HOA, ECB-203

Product Description

This document describes the hardware installation procedures for the ECB Series BACnet controllers.

The Distech Controls ECB Series controllers are designed to control and monitor various HVAC equipment such as roof top units, air handling units as well as chillers, boilers, and central plant applications. Moreover, these controllers are suitable for any lighting control and power measurement applications. This product line includes the following controllers: ECB-203, ECB-300, ECB-400 Series, and ECB-600 Series. Included in these series are the ECB-200, ECB-300, ECB-400, and ECB-600 UUKL controllers that are listed UL 864, 10th Edition, UUKL Smoke Control Equipment.



The ECB BACnet UUKL controllers (ECB 200, ECB 300, ECB 400, and ECB 600) are the only models to be used in the Distech Controls UUKL smoke control system. For detailed requirements, specifications, and procedures for installing and operating UL 864 Listed equipment, you must refer to the Distech Controls UUKL Smoke Control System [Design Guide](#) (UUKL Design Guide_UG_11_EN).

Failure to meet the requirements or follow the procedures in the Distech Controls UUKL Smoke Control System [Design Guide](#) can void the UL 864 Listing for smoke control equipment.

For controllers equipped with an operator interface (ECB-x50 models), refer to the [ECL-x50 and ECB-x50 Series Controller User Guide](#) for how to use this interface.

The ECB-600 Series are compatible with the IO Extension Module product line, which includes the following modules: ECx-400, ECx-410, ECx-420, and ECx-400 UUKL (refer to the [ECx-400 series IO Extension Module Hardware Installation Guide](#)).

Each controller uses the BACnet MS/TP LAN communication protocol.

This document describes the hardware installation procedures for the following controllers: ECB-200, ECB-300, ECB-400, and ECB-600 UUKL controllers only.



- These controllers are all built on a similar platform, but have different numbers of inputs and outputs. Moreover, each individual model has different amounts of digital and/or universal outputs. For more information on the specific layout and functionality of each controller, please refer to their individual datasheets.
- The following controllers are housed in small enclosures: ECB-203 Series and ECB-300 Series.
- The following controllers are housed in large enclosures: ECB-400 Series and ECB-600 Series.

General Installation Requirements

For proper installation and subsequent operation of the device, pay special attention to the following recommendations:

- It is recommended that the controller(s) be kept at room temperature for at least 24 hours before installation to allow any condensation that may have accumulated due to low temperature during shipping/storage to evaporate.
- Upon unpacking, inspect the contents of the carton for shipping damages. **Do not install a damaged device.**
- The device is designed to operate under environmental conditions that are specified in its datasheet.
- Ensure proper ventilation of the device and avoid areas where corroding, deteriorating or explosive vapors, fumes or gases may be present.
- Allow for proper clearance around the device's enclosure and wiring terminals to provide easy access for hardware configuration and maintenance.
- When installing in an enclosure, select one that provides sufficient surface area to dissipate any heat generated by the device and by any other devices installed in the enclosure. A metal enclosure is preferred. If necessary, provide active cooling for the enclosure.
- Orient the controller with the ventilation slots and power supply/output terminal block connectors towards the top to permit proper heat dissipation.
- The device's plastic enclosure has a back plate that is separable from the front plate allowing the back plates (with the connectors) to be shipped directly to the installation site while all the engineering is done in the office.

- The device's datasheet specifies the power consumption (amount of heat generated), the operating temperature range, and other environmental conditions the device is designed to operate under.
- Ensure that all equipment is installed according to local, regional, and national regulations.
- Do not drop the device or subject it to physical shock.
- If the device is used and/or installed in a manner not specified by Distech Controls, the functionality and the protection provided by the device may be impaired.



Any type of modification to any Distech Controls product will void the product's warranty



Take special care to keep the front and back plate aligned when separating and joining them.



Before installation of the Wireless Receiver, verify that local communication regulations allow the installation of wireless devices and available frequencies to be supported in your area. Refer to the [Open-to-Wireless™ Application Guide](#) for more information.



Take reasonable precautions to prevent electrostatic discharge to the device when installing, servicing or during operation. Discharge accumulated static electricity by touching one's hand to a well-grounded object before working with the device.

Device Markings (Symbols)

Certain markings (symbols) can be found on the controller and are defined as follows:

Symbol	Description
	CE marking: the device conforms to the requirements of applicable EC directives.
	Products must be disposed of at the end of their useful life according to local regulations.
	Read the Hardware Installation Guide for more information.
	UL marking: conforms to the requirements of the UL certification.
	FCC marking: This device complies with FCC rules part 15, subpart B, class B.
	Warning Symbol: Significant information required. Refer to the Hardware Installation Guide.
	Alternating Current
	Direct Current

General Wiring Recommendations



Risk of Electric Shock: Turn off power before any kind of servicing to avoid electric shock.

- All wiring must comply with electrical wiring diagrams as well as national and local electrical codes.
- To connect the wiring to a device, use the terminal connectors. Use a small flat screwdriver to tighten the terminal connector screws once the wires have been inserted (strip length: 0.25" (6 mm), tightening torque 0.5 Nm).
- Comply with all network and power supply guidelines outlined in the [Network Guide](#). For the UUKL controllers, refer to the Distech Controls UUKL Smoke Control System [Design Guide](#).
- Always use unshielded cabling with a minimum Category 5 (CAT5) cable for ethernet communications.
- Keep wiring separate according to their function and purpose to avoid any ambient noise transmission to other wires. Use strapping to keep these wires separated. For example, keep power, hazardous voltage, SELV, PELV, network, and input wiring separate from each other.
- The board connectors accept wires or flat cables ranging from 22 to 14AWG (0.644 to 1.630mm diameter) per pole. However, power cables must be between 18 and 14AWG (1.024 to 1.630mm diameter).
- Keep all wires away from high speed data transmission cables (for example, Ethernet, etc.).
- Do not connect the universal inputs, analog/digital outputs or common terminals to earth or chassis ground (unless stated otherwise).
- Keep input and output wiring in conduits, trays or close to the building frame if possible.

Controller Dimensions & Components

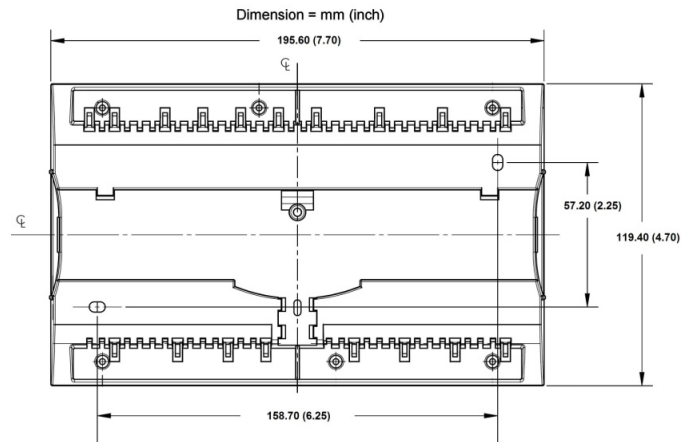

Figure 2: Rear view of large enclosure

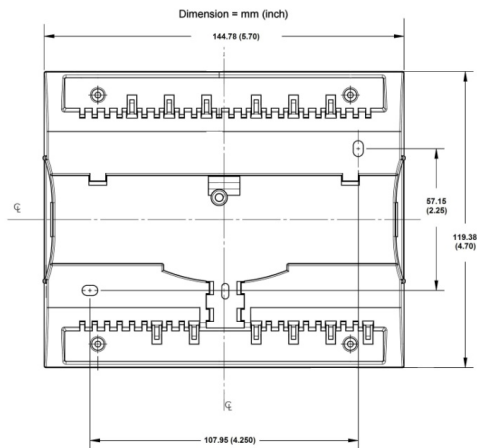

Figure 3: Rear view of small enclosure

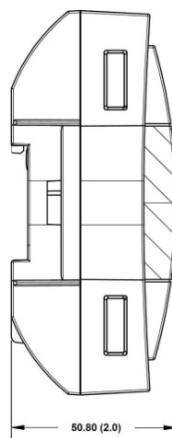

Figure 4: Side view of large and small enclosure

Mounting Instructions

The controllers can be mounted on a DIN rail to speed up the installation procedure. They are also equipped with two mounting holes 0.25" x 0.165" (6.35mm x 4.191mm). controllers can be mounted in a panel or on a wall by using appropriate screw types (use sheet metal, thread forming, or self-tapping screws accordingly).

The controller's mounting orientation must be horizontal with controller's back attached to a vertical wall surface.

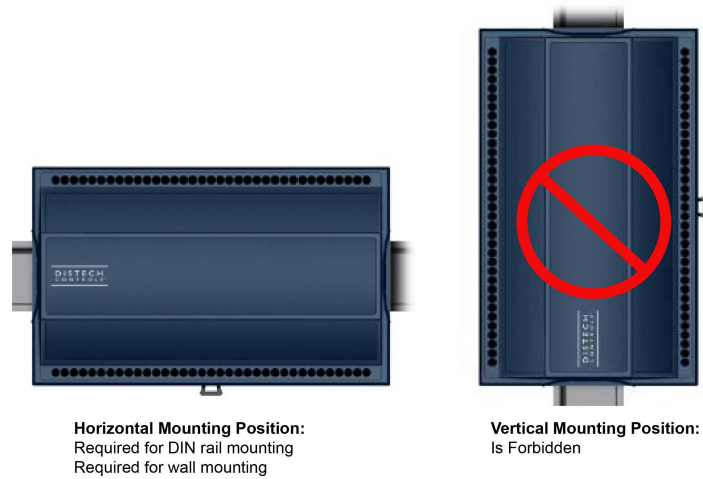

Figure 5: Permitted Mounting Positions

DIN Rail-Mounted Installation

1. Ensure the DIN rail is properly mounted on the wall.
2. Simply clip controller onto the DIN rail.



Wall-Mounted Installation

3. Open the enclosure by separating the front and back plate while pressing on the side clips.
4. Use the back plate's mounting holes to mark the location of any holes that need to be drilled.
5. Drill the holes.
6. Clean the surface and mount the controller using the appropriate screw types.

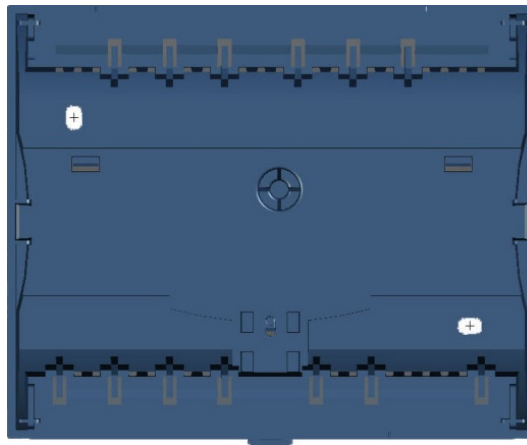

Power Wiring

Voltage for UUKL models: 24VAC; $\pm 15\%$, Class 2

Voltage for all non-UUKL models: 24VAC/DC; $\pm 15\%$, Class 2



This is a Class 2 Product. Use a Class 2 transformer only (rated at 100VA or less at 24VAC) to power the controller(s).

The [Network Guide](#) provides extensive information and requirements for powering a controller that uses a BACnet network for communications. It can be downloaded from our website. For the UUKL controllers, refer to the Distech Controls UUKL Smoke Control System [Design Guide](#).

It is recommended to wire only one controller per 24VAC transformer.

If only one 24VAC transformer is available, determine the maximum number of controllers that can be supplied using the following method to determine the required power transformer capacity:

- Add up the maximum power consumption of all controllers including external loads and multiply this sum by 1.3.
- If the resulting number is higher than 100VA, use multiple transformers.

Use an external fuse on the 24VAC side (secondary side) of the transformer, as shown below, to protect all controllers against power line spikes.

Maintain consistent polarity when connecting controllers and devices to the transformer. One terminal on the secondary side of the transformer must be connected to the building's ground. All 24V COM terminals of all controllers and peripherals throughout the BACnet MS/TP network must be connected to the grounded transformer terminal as shown below. This ensures that the 24V COM terminals of all devices connected to any BACnet MS/TP bus in the building are at the same potential.



Always use a separate transformer for each ECB-600 series controller and for each of its associated IO Extension Module (ECx-400s).

One terminal on the secondary side of each of these transformers must be connected to the building's ground and to the respective controller's or IO Extension Modules' 24V COM terminal.



A mechanical ground is unacceptable: Do not use a pipe, conduit, or duct work for a ground. The power supply must have a dedicated ground wire that comes from the main electrical supply panel.



Failure to maintain consistent polarity throughout the entire network will result in a short circuit and/or damage to the controller!

The COM terminals of the controller are internally wired to the 24V COM terminal of the power supply. Connecting a peripheral or another controller to the same transformer without maintaining polarity between these devices will cause a short circuit.

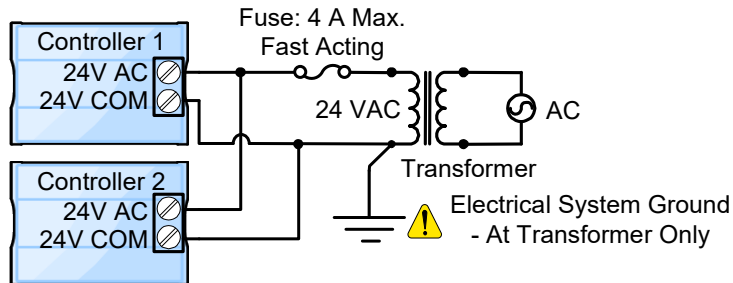

Figure 6: Power wiring – AC

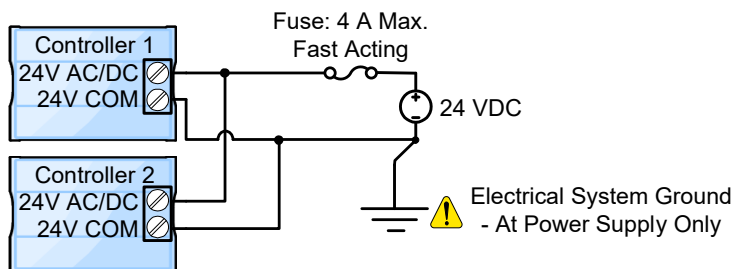

Figure 7: Power wiring – DC (for all non-UUKL models only)

Jumper Identification and Configuration

Controllers have the following onsite configurable jumpers.

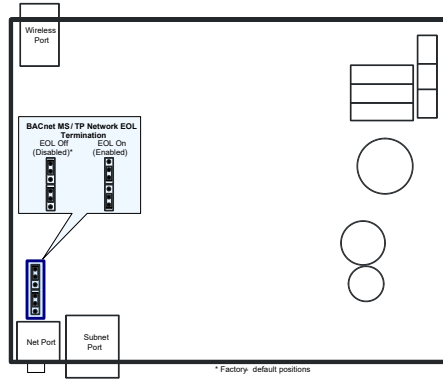

Figure 8: ECB-203 Controller Jumper Locations

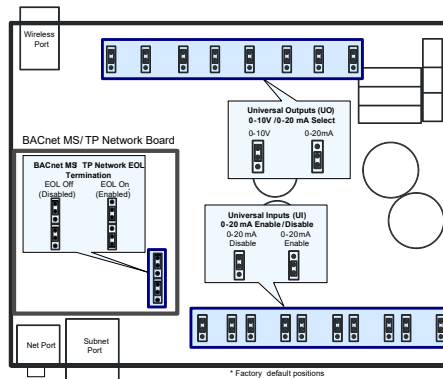

Figure 9: ECB-300 Controller Jumper Locations

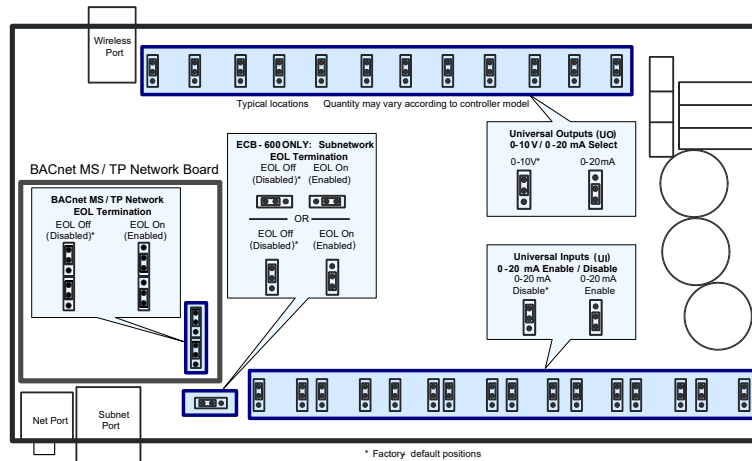

Figure 10: ECB-400 Series and ECB-600 Series Controller Jumper Locations

Input Wiring



Before connecting a sensor to the controller, refer to the installation guide of the equipment manufacturer.



- For a wire length less than 75' (23m), either a shielded or unshielded 18AWG wire may be used.
- For a wire up to 200' (61m) long, a shielded 18AWG wire is recommended.
- The shield of the wire should be grounded on the controller side only and shield length should be kept as short as possible.

Table 1 shows the ECB-203, ECB-300, ECB-400, and ECB-600 Series controller pulse and current input jumper support. Table 2 shows the available universal input (UIx) wiring methods.

Controller	Fast and Slow Pulse Inputs support		Current Input Jumper support: 0 to 10VDC / 0 to 20mA
	50Hz: 10ms minimum ON/OFF (Fast Pulse)	1Hz: 500ms minimum ON/OFF (Slow Pulse)	
ECB-203	None	UI1 to UI6	None
ECB-300	UI1 to UI4	UI5 to UI10	Yes; see <i>Table 2</i>
ECB-400 Series	UI1 to UI4	UI5 to UI12	
ECB-600 Series	UI1 to UI4	UI5 to UI16	

Table 1: Controller Input Support

Sensor Input Type	Input Connection Diagram
<input type="checkbox"/> Dry Contact input.	
<input type="checkbox"/> RTD input (for example, 1000Ω). <input type="checkbox"/> Thermistor Input (for example, 10kΩ type II and III).	
<input type="checkbox"/> Resistive input, (for example, use with 10kΩ and 100kΩ potentiometers).	
ECB-203 Series: <input type="checkbox"/> 0 to 20mA input used with a 2-wire, 0 to 20mA sensor powered by the controller's internal 15VDC power supply.	
ECB-203 Series: <input type="checkbox"/> 0 to 20mA input used with a 2-wire, 0 to 20mA sensor powered by an external 24VDC power supply.	
ECB-203 Series: <input type="checkbox"/> 0 to 20mA input used with a 3-wire, 0 to 20mA sensor powered by an external 24VAC power supply.	
ECB-203 Series: <input type="checkbox"/> 0 to 20mA input used with a sensor powered by its own power source.	
ECB-300, ECB -400, and ECB -600 Series: <input type="checkbox"/> 0 to 20mA input used with a 2-wire, 0 to 20mA sensor powered by the controller's internal 15VDC power supply. <input type="checkbox"/> For jumper location, see Jumper Identification and Configuration.	

Sensor Input Type	Input Connection Diagram
<p>ECB-300, ECB -400, and ECB -600 Series:</p> <ul style="list-style-type: none"> 0 to 20mA input used with a 2-wire, 0 to 20mA sensor powered by an external 24VDC power supply. For jumper location, see Jumper Identification and Configuration. 	
<p>ECB-300, ECB -400, and ECB -600 Series:</p> <ul style="list-style-type: none"> 0 to 20mA input used with a 3-wire, 0 to 20mA sensor powered by an external 24VAC power supply. For jumper location, see Jumper Identification and Configuration. 	
<p>ECB-300, ECB -400, and ECB -600 Series:</p> <ul style="list-style-type: none"> 0 to 20mA input used with a sensor powered by its own power source. For jumper location, see Jumper Identification and Configuration. 	
<ul style="list-style-type: none"> Voltage input used with a 3-wire 0 to 10VDC or 0 to 5VDC sensor powered by an external 24VAC power supply. 	
<ul style="list-style-type: none"> Voltage input used with a 0 to 10VDC or 0 to 5VDC sensor powered by its own power source. 	
<ul style="list-style-type: none"> Slow Pulse – Internal supply: 2-wire pulse meter for ECB-203, ECB 300, ECB 400, and ECB 600 Series :controllers Connect the pulse input according to the figure for a pulse meter that can pull-down a +5VDC supply with a 10KΩ pull-up resistor (internal supply type). Refer to Table 1 for more information on Controller Input Support 	
<ul style="list-style-type: none"> Fast Pulse – Internal supply: 2-wire pulse meter for ECB 300, ECB 400, and ECB 600 Series: controllers Connect the pulse input according to the figure for a pulse meter that requires more than 5VDC to operate using built in controller power source from 6VDC to 15VDC maximum. Refer to Table 1 for more information on Controller Input Support 	
<ul style="list-style-type: none"> Fast Pulse – External supply: 2-wire pulse meter for ECB 300, ECB 400, and ECB 600 Series: controllers Connect the pulse input according to the figure for a pulse meter that requires more than 5VDC to operate using an external power source from 6VDC to 27VDC maximum. Refer to Table 1 for more information on Controller Input Support 	

Table 2: Input Wiring

Output Wiring



Before connecting an output device (actuator, relay, etc.) to the controller, refer to the datasheet and installation guide of the equipment manufacturer.



- For a wire length less than 75' (23m) long, either a shielded or unshielded 18AWG wire may be used.
- For a wire length up to 200' (61m) long, a shielded 18AWG wire is recommended.
- The shield of the wire should be grounded on the controller side and the shield length should be kept as short as possible.
- For relay outputs (DOx); select appropriately-sized wiring suitable to the current load.
- To measure the state of a triac output, an external load must be connected.

Table 3 shows the ECB-203 ECB -300, ECB -400, and ECB-600 Series controller Output and Jumper support. Table 4 shows the available output wiring methods.

Controller	Digital (Triac) Outputs	Universal Outputs	Jumper 0 to 10VDC/0 to 20mA
ECB-203	5	3	
ECB-300	0	8	■
ECB-4x0 Series	0	12	■
ECB-4x3 Series	8	4	■
ECB-600 Series	0	12	■

Table 3: Controller Output Support

Control Output Type	Output Designation	Output Connection Diagram
<input type="checkbox"/> Discrete 0 or 12VDC digital, Pulse, or PWM output controlling a 12VDC relay. Maximum 60 mA (minimum load resistance 200Ω).	UOx	
<input type="checkbox"/> Current 0 to 20mA universal output & jumper configuration <input type="checkbox"/> For ECB-300, ECB-400, and ECB-600 Series only <input type="checkbox"/> For jumper location, see Jumper Identification and Configuration.	UOx	
<input type="checkbox"/> Linear 0 to 10VDC digital to analog output.	UOx	
<input type="checkbox"/> 0 to 10VDC voltage output controlling an analog actuator that is powered by an external 24VAC power source.	UOx	
<input type="checkbox"/> 24VAC externally-powered triac output controlling a floating actuator ¹ . <input type="checkbox"/> Ensure that the external power supply is grounded as shown.	DOx	
<input type="checkbox"/> 24VAC controller -powered triac output controlling a relay ¹ with line and neutral switching. <input type="checkbox"/> Ensure that the transformer's secondary winding is grounded as shown.	DOx	

Control Output Type	Output Designation	Output Connection Diagram
<input type="checkbox"/> 24VAC externally-powered triac output controlling a relay ¹ with line and neutral switching. <input type="checkbox"/> Ensure that the transformer's secondary winding is grounded as shown.	DOx	

Table 4: Output Wiring

1. Maximum output current for all digital triac outputs is 0.5A continuous or 1A @ 15% duty cycle for a 10-minute period.

Subnet-Wiring

The subnet is used to connect a range of Allure Series Communicating Sensors:

- The Allure EC-Smart-Vue Series sensor is a communicating room temperature sensor with backlit display graphical menus and VAV balancing capabilities.
- The Allure EC-Smart-Comfort and Allure EC-Smart-Air Communicating Sensors are a range of communicating room temperature sensors.

Connect Allure Series to the controller's **Subnet Port** with a standard Category 5e Ethernet patch cable fitted with RJ-45 connectors. Refer to the [Network Guide](#) for extensive information and requirements for the connection of the Allure Series. It contains information about network topology and length, cable type, setting the Subnet ID, etc. It can be downloaded from the www.distech-controls.com. See also the [Hardware Installation Guide](#) supplied with the Allure Series.

If you make your own patch cable, see the Allure Series Hardware Installation Guide.

Protect the controller's connector from being pulled on when a cable to Allure Series is connected. Create a strain-relief by looping the cable and attaching it to a solid object with a nylon tie so that a tug on the cable will not pull out the connector on the controller.

Subnet Wiring with the ECB-600 Series Controller

ECx-400 series IO Extension Modules are connected to the **SUBNET-** and **SUBNET+** terminals of ECB-600 series controller. The Network Guide provides extensive information and requirements to implement the subnetwork for the ECx-400 series IO Extension Modules. It contains information about network length, cable type, controller addressing, etc. It can be downloaded from our website. See also the Hardware Installation Guide supplied with the ECx-400 series IO Extension Module. For the UUKL controllers, refer to the Distech Controls UUKL Smoke Control System [Design Guide](#).

Communications Wiring

The Network Guide provides extensive information and requirements to implement a BACnet MS/TP network. It contains information about network and sub network length, cable type, device addressing, etc. It can be downloaded at the www.distech-controls.com website. For optimal performance, use Distech Controls 24 AWG (0.65 mm) stranded, twisted pair shielded cable or refer to the Network Guide for cable specification. The BACnet MS/TP communication wire is polarity sensitive and the only acceptable topology is to daisy-chain the cable from one controller to the next.

For the UUKL controllers, refer to the Distech Controls UUKL Smoke Control System [Design Guide](#).

- As shown in BACnet MS/TP Communications Wiring:
- The first and last daisy-chained BACnet MS/TP device must have its EOL resistors enabled / installed. All other devices must have their EOL resistor disabled (default factory setting).
 - When the BACnet MS/TP data bus is connected to a following device, twist data bus shields together.
 - Isolate all shields with electrical tape so there is no exposed metal that can touch ground or other conductors.
 - The shield of the data bus must be connected to the electrical system ground at only one point – usually at one end of the bus as shown below.
 - Connect no more than 50 devices to a BACnet MS/TP data bus.

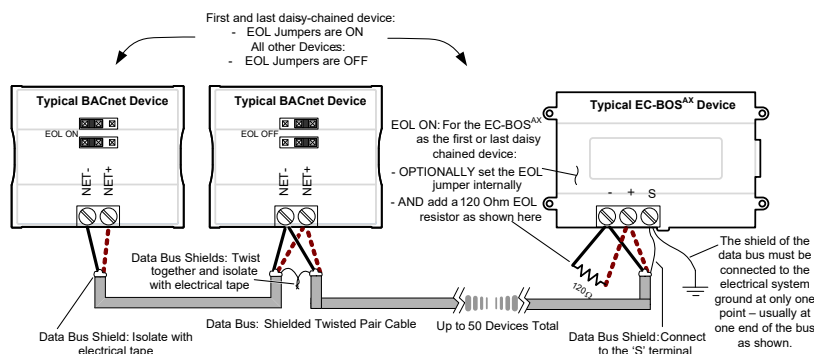

Figure 11: BACnet MS/TP Communications Wiring

If inserting multiple wires in the terminals, ensure to properly twist wires together prior to inserting them into the terminal connectors.

For more information and detailed explanations on network topology and wire length restrictions, refer to the [Network Guide](#), which can be downloaded from our website.

For the UUKL controllers, refer to the Distech Controls UUKL Smoke Control System [Design Guide](#).

Device Addressing

The [Network Guide](#) provides extensive information and requirements to implement a BACnet MS/TP network. It contains information about network planning and MAC Address numbering schemes. It can be downloaded from the www.distech-controls.com website.

For the UUKL controllers, refer to the Distech Controls UUKL Smoke Control System [Design Guide](#).

The MAC Address must be set according to your network planning document by setting the DIP switch located under the cover or when this DIP switch is set to 0 (all off), the MAC address can be set by connecting an Allure EC-Smart-Vue Series Communicating Sensor to the controller as shown in Step 5 of [Setting the Communicating Sensor Subnet ID](#) in the following section. An example of how to set the device's MAC Address DIP switch is shown below.

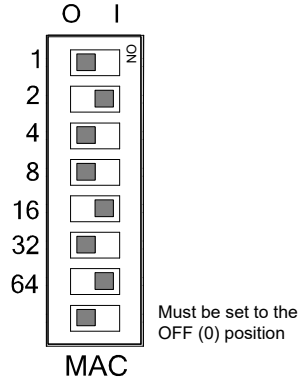

Figure 12: Typical Device MAC Address DIP Switch Set to 82

The address is the sum of the numbers set to ON. For example, if the second (2), fifth (16), and seventh (64) DIP switches are set to ON, the device MAC address is 82 (2 + 16 + 64). Only addresses from 1 to 127 are recommended to be used.

The controller must be power cycled after the MAC address DIP switch has been changed. The device instance (DevID) is automatically configured when setting the MAC Address to prevent network address conflict. The following formula is used to determine the device instance:

$$\text{DevID} = 364 * 1000 + \text{MAC}$$

For example:

MAC: 37

$$\text{DevID} = 364 * 1000 + 37 = 364037$$

The Device Instance can be changed once the controller has been commissioned through the network management software interface.

The Device Instance can be changed once the controller has been commissioned through the network management software interface or through the color LCD screen's Settings menu (when equipped).

Temporary Network Access

To temporarily access the BACnet MS/TP LAN for commissioning and maintenance purposes, connect a BACnet MS/TP Adaptor to the NET PORT audio plug. Wire a standard 1/8" (3.5 mm) three-conductor stereo jack as shown below.



The BACnet MS/TP Adaptor must have an electrically-isolated RS 485 port. Otherwise a ground path from the BACnet network will be made through the computer that will disrupt BACnet network communications.

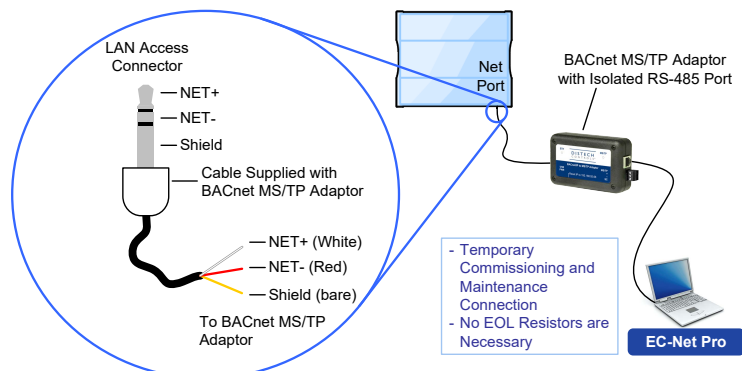



Figure 13: 1/8" (3.5 mm) Stereo Jack Connection for a Portable Router

Setting the Communicating Sensor Subnet ID

ECB Series controllers can be commissioned with an Allure EC-Smart-Vue Series Communicating Sensor by connecting it to the controller as shown in the wiring diagram at the end of this guide.

The default Subnet ID for an Allure EC-Smart-Vue Series Communicating Sensor is 1. To commission an ECB Series controller, the sensor's Subnet ID must be set to 1. If the sensor's Subnet ID has been set to another value (for example, the display flashes error code 1 with the Bell icon when the sensor is connected to a controller for commissioning), change the Subnet ID to 1 as follows:

1. Connect an Allure EC-Smart-Vue Series Communicating Sensor to the controller with a Cat 5e patch cable. Wait for the Bell icon and the number 1 to flash on the display.
2. Press and hold the Menu button  for 5 seconds to enter the password menu. 10000 is shown on the display.



Screen Timeout: 15 seconds



3. Press the down button  to set the number to 9995 (this is the default password).

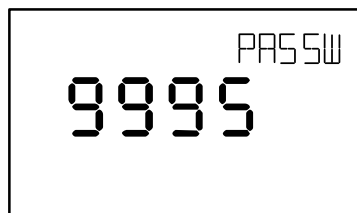

Screen Timeout: 15 seconds



4. Press the Menu button  to submit the password. Upon submitting the password, the GEN CFG menu appears on the display.



Screen Timeout: 30 seconds



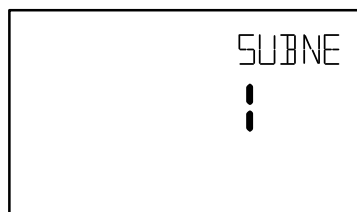

5. Press the down button  once to enter the **GEN CFG** submenu.

6. Press the Menu button  several times until SUBNET ID appears on the display. The current controller's Subnet ID is shown.

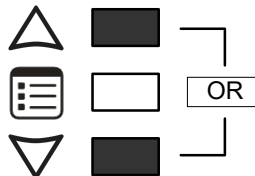

Screen Timeout: 30 seconds



7. Use the up and down buttons   to set the controller's Subnet ID to 1. *Tip:* Hold down either the up or down button to fast-advance the display value.

8. Press the Menu button  once.

9. Press and hold the Menu button  for 5 seconds to exit the configuration menu.

The Allure EC-Smart-Vue Series Communicating Sensor can now be used to go from one ECB Series controller to the next for commissioning purposes.

Commissioning ECB-Series Controllers

When using an Allure EC-Smart-View Series Communicating Sensor for commissioning ECB Series controllers (the DIP switch located on the faceplate is set to 0 (all off) and before code is downloaded to the controller EC-gfxProgram), connect the Allure EC-Smart-View Series Communicating Sensor to the controller with its Subnet ID set to 1.

During commissioning, the sensor is used to set the controller's BACnet® MAC Address.

Set the connected controller's MAC Address as follows:

1. Connect an Allure EC-Smart-View Series Communicating Sensor to the controller with a Cat 5e patch cable. Wait for the display to show the room temperature.
2. Press and hold the Menu button  for 5 seconds to enter the password menu. 10000 is shown on the display.



Screen Timeout: 15 seconds



3. Use the down button  to set the number to 9995 (this is the default password).



Screen Timeout: 15 seconds



4. Press the **Menu** button  to submit the password. Upon submitting the password, the **GEN CFG** menu appears on the display.



Screen Timeout: 30 seconds







5. Press the down button  once to enter the **GEN CFG** submenu. The **MAC ADDRESS** menu is shown with the current controller's BACnet MAC Address.

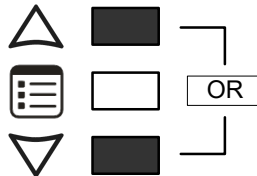

Screen Timeout: 30 seconds



6. Use the up and down buttons   to set the controller's MAC Address. Only addresses from 1 to 127 are recommended to be used.
7. Press the Menu button  once to apply the value.
8. Press and hold the Menu button  for 5 seconds to exit the configuration menu.

Once the controller's network is operational, the controller can be programmed EC-gfxProgram. For each Allure EC-Smart-View Series Communicating Sensor, set its Subnet ID number to the block number of its associated ComSensor block EC-gfxProgram. This is done in the sensor's **GEN CFG** menu under **SUBNET ID**.

Setting the BAUD Rate

By default, the BAUD rate for the controller is set to automatically detect the current communication BAUD rate of the connected BACnet MS/TP network (AUTO). This is the preferred setting for a controller. However, at least one controller on the BACnet MS/TP network data bus must have its BAUD rate set. The preference is to set the building controller's BAUD rate (if present). Otherwise, set the BAUD rate on one controller that will set the BAUD rate for all other controllers (to act as the master for setting the BAUD rate).

 When the BAUD rate is set to AUTO, the controller cannot initiate any communication until it has detected the baud rate of the BACnet MS/TP network. If all controllers on the BACnet MS/TP network are set to AUTO, then all controllers will not communicate.

Set the connected controller's BAUD rate as follows:

1. Connect an Allure EC-Smart-Vue Series Communicating Sensor to the controller with a Cat 5e patch cable. Wait for the display to show the room temperature.
2. Press and hold the Menu button  for 5 seconds to enter the password menu. 10000 is shown on the display.



Screen Timeout: 15 seconds



3. Use the down button  to set the number to 9995 (this is the default password).



Screen Timeout: 15 seconds





4. Press the **Menu** button  to submit the password. Upon submitting the password, the **GEN CFG** menu appears on the display.



Screen Timeout: 30 seconds







5. Press the down button  once to enter the **GEN CFG** submenu.
6. Use the Menu button  several times until **BAUD RATE** appears on the display. The current controller's BAUD rate is shown.



Screen Timeout: 30 seconds



7. Use the up and down buttons   to set the controller's Baud rate. The **AUTO** setting detects and uses the current baud rate being used by the BACnet MS/TP network.
8. Press the Menu button  once to apply the value.
9. Press and hold the Menu button  for 5 seconds to exit the configuration menu.

Wireless Installation

When connected to a Wireless Receiver, controllers can receive input signals from a wide selection of wireless devices. Compatible wireless devices include temperature sensors, duct sensors, window/door contacts and light switches. These devices are easy to install, and can be mounted on a wide range of building materials.



Before connecting any wireless equipment to the controller, refer to the [Open-to-Wireless Application Guide](#).

Connecting the Wireless Receiver

The Wireless Receiver is connected to the controller using a 2m (6.5ft) telephone cable with 4P4C modular connectors at both ends. Do not exceed this cable length. The Wireless Receiver's telephone socket is located inside the device. To locate it, open the Wireless Receiver by separating its front and back plates.

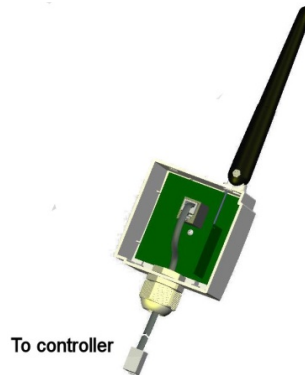

Figure 14: Location of the Wireless Receiver's telephone socket

Connecting to the Controller's Wireless Port

Each controller has a wireless port in which one end of the Wireless Receiver's telephone cable plugs in.

Strain relief and Terminal Block Cover

In certain jurisdictions, terminal block covers are required to meet local safety regulations. Strain reliefs and terminal block covers are available for controllers housed in large enclosures and are used to relieve tension on the wiring and conceal the controllers' wire terminals. Strain reliefs and terminal block covers are optional and are sold as peripherals.

Prior to connecting all wires, it is recommended to install the strain relief. Three screws are provided for its installation under the bottom part of the enclosure. Tie wraps can then be used to group wires together and attach them securely to the strain relief in an effort to relieve undue tension. If necessary, the terminal block cover can then be clipped on to the strain relief as shown below.

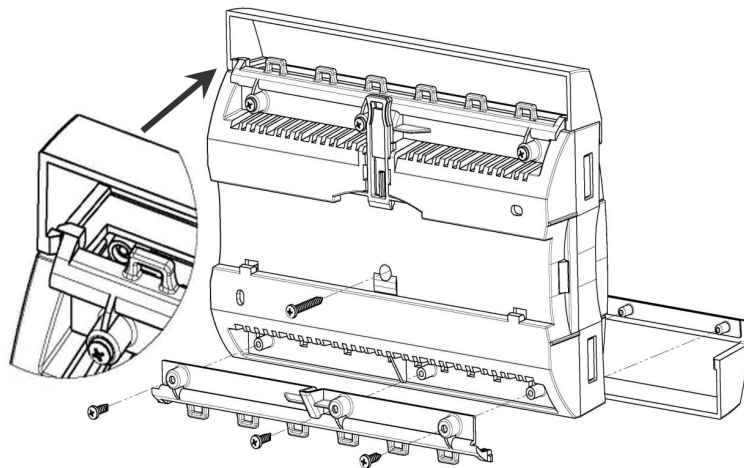

Figure 15: Large enclosure strain relief and terminal block cover installation

Maintenance



Unplug device before any kind of servicing.

The device requires minimal maintenance, but it is important to take note of the following:

- If it is necessary to clean the outside of the device, use a dry cloth.
- Retighten terminal connector screws annually to ensure the wires remain securely attached.

Disposal

The Waste Electrical and Electronic Equipment (WEEE) Directive set out regulations for the recycling and disposal of products. The WEEE2002/96/EG Directive applies to standalone products, for example, products that can function entirely on their own and are not a part of another system or piece of equipment.

For this reason, Distech Controls products are exempt from the WEEE Directive. Nevertheless, Distech Controls products are marked with the WEEE



symbol , indicating devices are not to be thrown away in municipal waste.

Products must be disposed of at the end of their useful life according to local regulations and the WEEE Directive.

North American Emissions Compliance

United States



Changes or modifications not expressly approved by Distech Controls could void the user's authority to operate the equipment.

This equipment has been tested and found to comply with the limits for a Class B digital device, pursuant to Part 15 of the FCC Rules. These limits are designed to provide reasonable protection against harmful interference in a residential and commercial installation. This equipment generates, uses and can radiate radio frequency energy and, if not installed and used in accordance with the instructions, may cause harmful interference to radio communications. However, there is no guarantee that interference will not occur in a particular installation. If this equipment does cause harmful interference to radio or television reception, which can be determined by turning the equipment off and on, the user is encouraged to try to correct the interference by one or more of the following measures:



- Reorient or relocate the receiving antenna.
- Increase the separation between the equipment and receiver.
- Connect the equipment into an outlet on a circuit different from that to which the receiver is connected.
- Consult the dealer or an experienced radio/TV technician for help.

Canada

This Class (B) digital apparatus meets all the requirements of the Canadian Interference-Causing Equipment Regulations.

Cet appareil numérique de la Classe (B) respecte toutes les exigences du Règlement sur le matériel brouilleur du Canada.

Typical Air Handling Unit Application Wiring Diagram

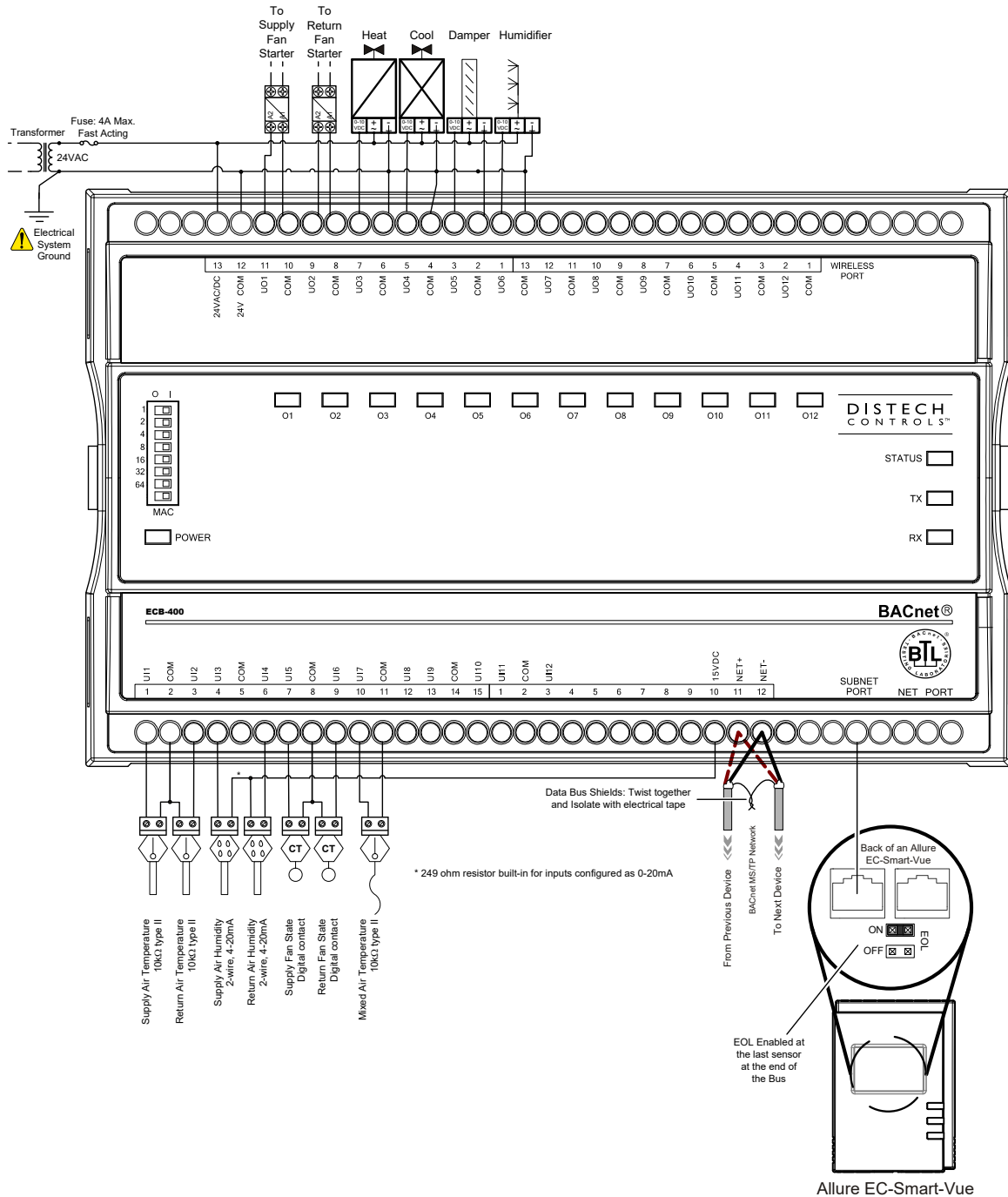

Figure 16: Typical Power and Network Connections with an Allure EC-Smart-Vue sensor



Although only the Allure EC-Smart-Vue is shown here, any other Allure Series Communicating Sensor can be connected to the subnet port in this manner. Refer to the sensor's corresponding [Hardware Installation Guide](#) for more details.

Troubleshooting Guide

Controller is powered but does not turn on

Fuse has blown	Disconnect the power. Check the fuse integrity. Reconnect the power.
Power supply polarity	Verify that consistent polarity is maintained between all controllers and the transformer. Ensure that the 24VCOM terminal of each controller is connected to the same terminal on the secondary side of the transformer. See <i>Power Wiring</i> .

Controller cannot communicate on a BACnet MS/TP network

Absent or incorrect supply voltage	1. Check power supply voltage between 24VAC \pm 15% and 24VCOM pins and ensure that it is within acceptable limits. 2. Check for tripped fuse or circuit breaker.
Overloaded power transformer	Verify that the transformer used is powerful enough to supply all controllers.
Network not wired properly	Double check that the wire connections are correct.
Absent or incorrect network termination	Check the network termination(s).
Max Master parameter	Configure the maximum number of master device on the MS/TP network in all devices to the controller's highest MAC address used on the MS/TP trunk.
There is another controller with the same MAC Address on the BACnet MS/TP data bus	Each controller on a BACnet MS/TP data bus must have a unique MAC Address. Look at the MAC Address DIP switch on the faceplate or under the cover of the controller. If it is set to 0 (all off), use an Allure EC-Smart-Vue sensor to check the MAC Address.
There is another controller with the same Device ID on the BACnet intranetwork	Each controller on a BACnet intranetwork (the entire BACnet BAS network) must have a unique Device ID. Use an Allure EC-Smart-Vue sensor to check the Device ID of each controller.

Controller communicates well over a short network, but does not communicate on large network

Network length	Check that the total wire length does not exceed the specifications of the <i>Network Guide</i> .
Wire type	Check that the wire type agrees with the specification of the <i>Network Guide</i> .
Network wiring problem	Double check that the wire connections are correct.
Absent or incorrect network termination	Check the network termination(s). Incorrect or broken termination(s) will make the communication integrity dependent upon a controller's position on the network.
Number of controllers on network segment exceeded	The number of controllers on a channel should never exceed 50. Use a router or a repeater in accordance to the <i>Network Guide</i> .
Max Master parameter	Configure the maximum number of master device on the MS/TP network in all devices to the controller's highest MAC address used on the MS/TP trunk.
There is another controller with the same MAC Address on the BACnet MS/TP data bus	Each controller on a BACnet MS/TP data bus must have a unique MAC Address. Look at the MAC Address DIP switch on the faceplate or under the cover of the controller. If it is set to 0 (all off), use an Allure EC-Smart-Vue sensor to check the MAC Address.
There is another controller with the same Device ID on the BACnet intranetwork	Each controller on a BACnet intranetwork (the entire BACnet BAS network) must have a unique Device ID. Use an Allure EC-Smart-Vue Series Communicating Sensor to check the Device ID of each controller.

I/O Extension Module cannot communicate on the subnetwork

Absent or incorrect supply voltage	1. Check power supply voltage between 24VAC \pm 15% and 24VCOM pins and ensure that it is within acceptable limits. 2. Check for tripped fuse or circuit breaker.
Overloaded power transformer	Verify that the transformer used is powerful enough to supply all controllers. See <i>Power Wiring</i> .
Network not wired properly	Double check that the wire connections are correct.
There is another controller with the same Subnet ID on the subnetwork	Each I/O Extension Module on the subnetwork must have a unique Subnet ID. Look at the Subnet ID DIP switch on the faceplate of each I/O Extension Module.
Network length	Check that the total wire length does not exceed the specifications in the <i>Network Guide</i> .
Wire type	Check that the wire type agrees with the specification of the <i>Network Guide</i> .
Absent or incorrect network termination	Check the network termination(s). Only the last ECx-400 I/O Extension Module must have its EOL termination set to ON. When one or more Allure EC-Smart-Vue sensors are connected to the controller, only the last sensor must have its EOL termination set to ON. See the <i>Network Guide</i> for more information.

Hardware input is not reading the correct value

Input wiring problem	Check that the wiring is correct according to this manual and according to the peripheral device's manufacturer.
Configuration problem	Using EC-gfxProgram, check the configuration of the input. Refer to the EC-gfxProgram user guide for more information.
Over-voltage or over-current at an input	An over-voltage or over-current at one input can affect the reading of other inputs. Respect the allowed voltage / current range limits of all inputs. Consult the appropriate datasheet for the input range limits of this controller.
Open circuit or short circuit	Using a voltmeter, check the voltage on the input terminal. For example, for a digital input, a short circuit shows approximately 0V DC and an open circuit shows approximately 5V DC.

Hardware output is not operating correctly

Fuse has blown (Auto reset fuse)	Disconnect the power and outputs terminals. Then wait a few seconds to allow the auto-reset fuse to cool down. Check the power supply and the output wiring. Reconnect the power.
Output wiring problem	Check that the wiring is correct according to this manual and according to the peripheral device's manufacturer.
Configuration problem	Using EC-gfxProgram, check the configuration of the input. Refer to the EC-gfxProgram user guide for more information.

0 to 10V output, 24VAC powered actuator is not moving.	Check the polarity of the 24VAC power supply connected to the actuator while connected to the controller. Reverse the 24VAC wire if necessary.
--	--



Wireless devices not working correctly

Device not associated to controller	Using EC- <i>gfx</i> Program, check the configuration of the input. Refer to the <i>EC-gfxProgram user guide</i> for more information.
Power discharge	1. Recharge device with light (if solar-powered) or replace battery (if battery-powered), 2. Ensure sufficient light intensity (200lx for 4 hours/day).
Device too far from the Wireless Receiver	Reposition the device to be within the range of the Wireless Receiver. For information on typical transmission ranges, refer to the <i>Open-to-Wireless Application Guide</i> .
Configuration problem	Using the device configuration plug-in or wizard, check the configuration of the input. Refer to the <i>Wireless Battery-less Sensors and Switches Solutions Guide</i> for more information.



Rx/Tx LEDs

RX LED not blinking	Data is not being received from the BACnet MS/TP data bus.
TX LED not blinking	Data is not being transmitted onto the BACnet MS/TP data bus.

Status LED– Normal Operation

One fast blink 	Initialization: The device is starting up.
Fast blink continuous:  (150ms On, 150ms Off, continuous)	Firmware upgrade in progress. Controller operation is temporarily unavailable. The new firmware is being loaded into memory. This takes a few seconds. Do not interrupt power to the device during this time.
The Status LED is always OFF	The controller is operating normally.

Status LED blink patterns – Repeats every 2 seconds (highest priority shown first)

Long Long Long blink  (800ms On, 300ms Off, 800ms On, 300ms Off, 800ms On)	The device has not received a BACnet token, and therefore cannot communicate on the network: Verify that the controller's MAC Address is unique on the BACnet MS/TP Data Bus – see Device Addressing. Make sure the controller's BAUD rate is the same as the BACnet MS/TP Data Bus' BAUD rate (see Setting the BAUD Rate (optional)). Verify that the Max Master is set high enough to include this controller's MAC Address (See the Network Guide).
Short Short Long blink  (150ms On, 300ms Off, 150ms On, 300ms Off, 800 ms On)	Poor-quality power; The device has browned-out: The voltage at the 24VAC and 24VCOM terminals has gone below the device's acceptable limit during power up.
Short Long blink  (150ms On, 300ms Off)	Invalid MAC address: The device's MAC address is set to zero (0) or is set to an address higher than the Max Master. See the Network Guide.

For issues with the Allure EC-Smart-Vue Series Communicating Sensor, refer to the Allure EC-Smart-Vue Series Communicating Sensor Hardware Installation Guide.

Specifications subject to change without notice.

Eclipse, Distech Controls, the Distech Controls logo, EC-Net, Allure, and Allure UNITOUCH are trademarks of Distech Controls Inc. BACnet is a registered trademark of ASHRAE; BTL is a registered trademark of the BACnet Manufacturers Association. All other trademarks are property of their respective owners.

©, Distech Controls Inc., All rights reserved.

Global Head Office - 4205 place de Java, Brossard, QC, Canada, J4Y 0C4 - EU Head Office - ZAC de Sacuny, 558 avenue Marcel Mérioux, 69530 Brignais, France